

OPERATION MANUAL

OSCILLOSCOPE

MODEL 5509

KIKUSUI ELECTRONICS CORPORATION

772101

Power Requirements of this Product

Power requirements of this product have been changed and the relevant sections of the Operation Manual should be revised accordingly.

(Revision should be applied to items indicated by a check mark)

Input voltage

The input voltage of this product is _____ VAC,
and the voltage range is _____ to _____ VAC. Use the product within this range only.

Input fuse

The rating of this product's input fuse is _____ A, _____ VAC, and _____.

WARNING

- To avoid electrical shock, always disconnect the AC power cable or turn off the switch on the switchboard before attempting to check or replace the fuse.
- Use a fuse element having a shape, rating, and characteristics suitable for this product. The use of a fuse with a different rating or one that short circuits the fuse holder may result in fire, electric shock, or irreparable damage.

AC power cable

The product is provided with AC power cables described below. If the cable has no power plug, attach a power plug or crimp-style terminals to the cable in accordance with the wire colors specified in the drawing.

WARNING

- The attachment of a power plug or crimp-style terminals must be carried out by qualified personnel.

Without a power plug

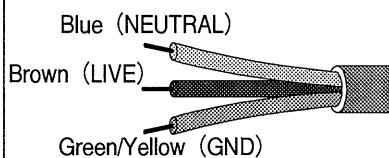

Without a power plug

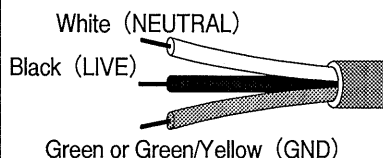

Plugs for USA

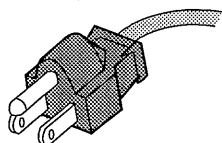

Plugs for Europe

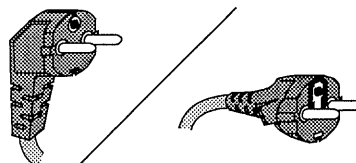

Provided by Kikusui agents

Kikusui agents can provide you with suitable AC power cable.
For further information, contact your Kikusui agent.

Another Cable _____

TABLE OF CONTENTS

	<u>PAGE</u>
1. GENERAL	1
1.1 Description	1
1.2 Features	1
2. SPECIFICATION	3
3. OPERATING INSTRUCTIONS	10
3.1 Explanation of Front Panel	10
3.2 Explanation of Rear Panel	15
3.3 Explanation of Bottom Panel	16
3.4 Precautions in Operation	20
3.5 Line Voltage Conversion	21
4. OPERATING PROCEDURE	23
4.1 Preliminary Procedure	23
4.2 Selection of TRIG MODE	25
4.3 Selection of TRIGGERING Switches	27
4.4 Adjustment of LEVEL Knob	29
4.5 Sweep Magnification	31
4.6 EXT HOR (External Horizontal) Operation	32
4.7 Z-AXIS INPUT (External Intensity Modulation) Operation	33

772102

	<u>PAGE</u>
5. METHODS OF MEASUREMENTS	35
5.1 Connection Method of Input Signal	35
5.2 Voltage Measurement	39
5.3 Current Measurement	40
5.4 Time Measurement	41
5.5 Frequency Measurement	42
5.6 Measurement of Phase Difference	44
5.7 Characteristics of Pulse Waveform	45
6. CALIBRATION	48
6.1 General	48
6.2 Check and Adjustment of DC Power Supply	48
6.3 Adjustment of Vertical Axis	52
6.4 Adjustment of Trigger Center	57
6.5 Adjustment of Time Axis	57
6.6 Adjustment of Horizontal Axis	58
6.7 Adjustment of CRT Circuit	59
6.8 Calibration of Probe	59
7. BLOCK DIAGRAM	62

* Schematic circuit diagram

1. GENERAL

1.1 Description

Kikusui Model 5509 Oscilloscope is a trigger-synchronized single-channel portable oscilloscope with a 133-mm (5.24 in.) round high-bright low-distortion cathode ray tube. Its sensitivity is 10 mV/DIV, bandwidth 10 MHz, and sweep speed 200 nsec/DIV (under 5 × MAG mode). It is sturdy and easy to operate, and it can be used for research and development of various electronic devices as well as for production and maintenance service. Features of the 5509 can be summarized as follows:

1.2 Features

- o Front frame made of aluminium diecast:

To provide a neat external view and a sufficient mechanical strength for maintenance service, the front frame is made of aluminium diecast.

- o Excellent manipulatability:

The 5509 provides an excellent manipulatability with light-torque rotary switches and pushbutton switches.

- o Highly bright CRT:

The 5509 employs a highly bright CRT which is capable of waveform display at a very high sweep speed.

- o Stable acceleration voltage:

The acceleration voltage of the 5509 is very stable against line voltage variation, as this high voltage is regulated with a unique control circuit.

- o Rotation coil for trace leveling:

The 5509 employs a rotation coil which enables you to adjust (rotate) the base line for leveling when it has become slanted by terrestrial magnetism. Adjustment can be done at the front panel.

- o Dual FET's for DC balance:

The 5509 employs dual FET's, attaining excellent DC balance and eliminating temperature drift.

- o Easy synchronization of TV (video) waveforms:

The trigger circuit has a TV synchronization circuit for easy synchronization of video waveforms. When triggering is set in the TV mode, a TV synchronization circuit is connected to the trigger circuit and the trigger mode is switched between TV.V and TV.H in conformity with the sweep time (linked to the TIME/DIV switch).

- o Excellent triggering feature:

The triggering sensitivity is higher than 0.5 DIV of amplitude on the CRT screen for a frequency range of 3 Hz - 10 MHz. An HF-REJ switch is incorporated so that stable triggering is attained even with a waveform on which noises are superimposed.

- o Maximum sweep time 200 nsec/DIV (with 5 × MAG):

The sweep time can be magnified by 5 times. By magnifying the sweep time of 1 μsec/DIV by 5 times, a sweep time as fast as 200 nsec/DIV can be attained.

772105

2. SPECIFICATION

Cathode-ray Tube

Item	Spec.	Remarks
Type	Round, 133 mm	(5.24 in.)
Fluorescent screen	B31	Green
Acceleration voltage	Approx. 1600 V	Regulated
Area	8 × 10 DIV	1 DIV = 9.5 mm (0.37 in.)
Unblanking	DC-coupling	

79.8.28

772106A

Vertical Axis

Item	Spec.	Remarks
Sensitivity	10 mV/DIV ~ 5 V/DIV, 9 ranges	1-2-5 sequence
Sensitivity accuracy	Better than $\pm 5\%$ of panel indicated value when VARIABLE knob is set in CAL position	1 kHz, at 4 or 5 DIV
Continuously-variable sensitivity adjustment	Panel indicated value can be continuously attenuated to a factor of 2.5 or over	
Frequency bandwidth	DC: DC ~ 10 MHz AC: 2 Hz ~ 10 MHz	50 kHz, 8 DIV reference, within -3 dB
Rise time	Approx. 35 nsec	Calculated value
Input impedance	1 M Ω $\pm 2\%$, approx. 25 pF	Probe can be used
Input terminal	BNC receptacle	
Maximum allowable input voltage	600 Vp-p, for 1 minute. 400 Vp-p for 10, 20, and 50 mV/DIV ranges.	DC + AC peak, frequency not higher than 1 kHz
Input coupling selection	AC, DC, GND	
Base line shift caused by range selection	Less than 0.5 DIV	Including shift caused by disturbance of DC balance
Linearity	When signal of 4 DIV in center of CRT is moved vertically for full effective screen area, change in vertical amplitude of signal is less than 0.2 DIV.	

5500

83.6.9

772107A

Triggering

Item	Spec.	Remarks
Trigger modes	<p>NORM When trigger signal is removed, base line is blanked out and sweep is in STANDBY state.</p>	<p>Satisfies the trigger sensitivity specification.</p>
	<p>AUTO When trigger signal is removed, sweep is in AUTO (FREE RUN) mode.</p>	<p>Satisfies the trigger sensitivity specification for periodically signal of 50 Hz or over.</p>
	<p>TV TV sync. separator circuit is connected to trigger circuit. When trigger signal is removed, sweep is in AUTO (FREE RUN) mode.</p>	<p>100 msec ~ 100 μsec TV·V 10 μsec ~ 1 μsec TV·H</p>
Trigger source	<p>INT Synchronized to vertical-axis input terminal signal (signal displayed on CRT).</p>	
	<p>EXT Synchronized to EXT TRIG input terminal signal.</p>	<p>Used in common for EXTHOR input terminal.</p>
<p>Internal trigger sensitivity</p> <p>WIDE</p> <p>HF·REJ</p> <p>TV</p>	<p>3 Hz ~ 10 MHz: 0.5 DIV</p> <p>3 Hz ~ 50 kHz: 0.5 DIV</p> <p>Video signal amplitude: 1.0 DIV</p>	
<p>External trigger sensitivity</p> <p>WIDE</p> <p>HF·REJ</p> <p>TV</p>	<p>3 Hz ~ 10 MHz: 0.5 V</p> <p>3 Hz ~ 50 kHz: 0.5 V</p> <p>Video signal: 1.0 V</p>	

Item	Spec.	Remarks
Polarity	"+" and "-"	
Coupling	WIDE, HF REU	
EXT trigger input impedance	Approx. 100 k Ω , approx. 20 pF	
Maximum allowable input impedance	100 V _{p-p} (DC + AC peak)	Frequency not higher than 1 kHz
External input terminals	Binding post terminals, spacing 19 mm (0.75 in.)	

79.8.28

772109A

Horizontal Axis

Item	Spec.	Remarks
Sweep time	1 μ sec ~ 100 msec/DIV, 6 ranges	$\times 10$ -step
Sweep time accuracy	Better than $\pm 3\%$ of panel indicated value VARIABLE knob set in CAL position	
Continuously variable range of sweep time	Continuously variable to 10 times or over of panel indicated value	
Sweep time magnification	5 expansion	
Sweep magnification accuracy	$\pm 5\%$	
Position shift caused by magnification	Less than 1 DIV at CRT screen center	
External sweep sensitivity	200 mV/DIV or over	
Frequency bandwidth	DC ~ 500 kHz (within -3 dB)	50 kHz, 10 DIV reference
Input impedance	Approx. 100 k Ω , approx. 20 pF	
Maximum allowable input voltage	100 V _{p-p} (DC + AC peak)	Frequency not higher than 1 kHz
X-Y phase difference	Within 3 $^\circ$ at 10 kHz	

772110

Z Axis

Item	Spec.	Remarks
Sensitivity	Intensity modulation discernible with minimum 3 V	
Frequency range	DC ~ 5 MHz	
Polarity	Positive: Brightened Negative: Darkened	
Input resistance	Approx. 10 k Ω	
Input terminals	Binding post terminals, spacing 19 mm (0.75 in.)	

Calibration Voltage

Item	Spec.	Remarks
Waveform	Square wave, positive polarity	
Output voltage	1 V _{p-p} , $\pm 3\%$	
Frequency	1 kHz $\pm 25\%$	
Duty ratio	45 : 55 or higher	
Output terminal	Chip terminal	

79.8.28

712111A

Power Requirements

Item	Spec.	Remarks
AC line voltage	100, 110, 120, 220, 230, or 240 V +10%	Selectable with connector and pins of voltage selector board
Frequency	50 ~ 60 Hz	
Power consumption	Approx. 20 VA	

Mechanical Specification

Item	Spec.	Remarks
Overall dimensions	165 W x 237 H x 402 D mm (6.50W x 9.33H x 15.83D in.) 170 W x 265 H x 460 D mm (6.69W x 10.43H x 18.11D in.)	Maximum dimensions
Weight	Approx. 7 kg (15.4 lb.)	



Accessories





Operation manual	1
942A Type Terminal Adaptor	1
PO60-S Type Probe (10:1, 1:1)	1

85.1.29 772112D

3. OPERATING INSTRUCTIONS

3.1 Explanation of Front Panel (See Fig. 1)

No.	Panel mark	Description
①		Graticule scale with blue filter
②		Bezel for clamping filter
③	INTEN POWER OFF	Intensity control knob with POWER switch. Extremely counterclockwise position is POWER OFF. As turned clockwise, POWER is turned ON and intensity increases.
④	TRACE ROTATION	Semi-fixed resistor for level (horizontal inclination) adjustment of base line which may be inclined by terrestrial magnetism.
⑤	FOCUS	So adjust this knob that the trace displayed on the screen becomes sharpest.
⑥	POSITION 	For vertical positioning of the trace. The trace moves upward as this knob is turned clockwise, and vice versa.
⑦	VOLTS/DIV	Vertical sensitivity selector switch for 10 mV/DIV ~ 5 V/DIV, with 9 ranges. So adjust this switch that the input signal (a wide range of input voltage from several millivolts to several tens volts) is displayed with an appropriate amplitude on CRT screen.
⑧	VARIABLE  CAL	Continuously-variable adjustment of vertical sensitivity. The sensitivity selected by VOLTS/DIV switch ⑦ can be attenuated to a factor of 1/2.5 or over. At CAL position (extremely clockwise position), sensitivity is calibrated to the value indicated by VOLTS/DIV switch.

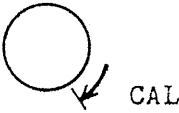
No.	Panel mark	Description
⑨	INPUT	Input terminal of vertical amplifier. The input signal can be connected with BNC connector or probe.
⑩	 AC DC	Pushbutton switch for selection of input coupling mode of vertical amplifier. The popped up state () is for AC coupling and the depressed state () for DC coupling. AC coupling is used for observation of AC components alone; DC coupling is for observation of overall components including DC component.
⑪	 GND	Pushbutton switch for grounding the input line of vertical amplifier. When this switch is depressed (grounded), INPUT terminal ⑨ becomes open. This switch is used for checking of 0 level, etc.
⑫	VARIABLE 	Continuously-variable adjustment of sweep time. The sweep time selected by TIME/DIV switch ⑬ is continuously-variable to a factor of 10 or over. At CAL position (extremely clockwise position), sweep time is calibrated to the value indicated by TIME/DIV switch.
⑬	TIME/DIV	Sweep time selector switch for 100 msec/DIV - 1 µsec/DIV and EXT HOR. So adjust this switch that the measured signal (from DC to high frequency) is displayed with an appropriate time base. The EXT HOR (external horizontal sweep) is for stationary sweep or X-Y operation.

80.5.29

778114A

No.	Panel mark	Description
⑭	EXT HOR OR TRIG IN	Common input terminal for external sweep input and external trigger input. When TIME/DIV switch ⑬ is set in the EXT HOR position, the trace is swept on X-axis (horizontal axis) with the signal of this input terminal. When triggering switch ⑰ is set in the EXT (⎓) position, the displayed waveform is synchronized with the signal of this input terminal.
⑮	GND	GND terminal (binding post) for grounding of this oscilloscope. Spacing is 19 mm (0.75 in.) for convenience when used in conjunction with EXT HOR OR TRIG IN terminal.
⑯	LEVEL ← 0 → +	Trigger level adjustment for displaying stationary waveform. The trigger level rises as this knob is turned toward → + and it falls as the knob is turned toward ←.
⑰ ⑱ ⑲	<p>TRIGGERING</p> <p> <input checked="" type="checkbox"/> INT WIDE + <input type="checkbox"/> EXT HF REJ - </p> <p> <input type="checkbox"/> <input type="checkbox"/> <input type="checkbox"/> </p>	<p>Triggering switch circuit consisting of trigger source selector switch ⑲, input coupling selector switch ⑱, and slope selector switch ⑰.</p> <p>Trigger source selector switch ⑲</p> <p><input checked="" type="checkbox"/> INT: Trigger source is internal (the signal displayed on CRT screen is used as the trigger signal).</p> <p><input type="checkbox"/> EXT: Trigger source is external (the signal applied through TRIG IN terminal ⑭ is used as the trigger signal).</p>

74.8.28

772115A

No.	Panel mark	Description
		<p>Input coupling selector switch (18)</p> <p><input type="checkbox"/> WIDE: Trigger circuit is AC-coupled to the trigger source and triggering is made for a range of 3 Hz ~ 10 MHz.</p> <p><input type="checkbox"/> HF·REJ: High frequency reject filter (50 kHz, -3 dB) is connected to the trigger source and triggering is made through AC coupling.</p> <p>Triggering slope selector switch (17)</p> <p><input type="checkbox"/> +: Triggering is effected when trigger signal crosses the trigger level from negative side to positive side.</p> <p><input type="checkbox"/> -: Triggering is effected when trigger signal crosses the trigger level from positive side to negative side.</p>
(20)	POSITION PULL 5×MAG	<p>Horizontal positioning knob when is used in common for 5 × sweep magnification. The displayed waveform moves rightward as this knob is turned clockwise, and vice versa. When this knob is pulled out, the sweep time is multiplied by a factor of 5, thereby magnifying the horizontal amplitude by 5 times. (When in EXT HOR operation, sensitivity is increased by 5 times, although the frequency range becomes narrower.)</p>

772116

No.	Panel mark	Description
②① ②② ②③	TRIG MODE NORM AUTO TV <input type="checkbox"/> <input type="checkbox"/> <input type="checkbox"/>	<p>Pushbutton switches for selection of trigger mode.</p> <p>NORM ②③ : When trigger signal is removed, trace is blanked out and sweep is in STANDBY state. Used primarily for observation of signals lower than 50 Hz.</p> <p>AUTO ②② : When trigger signal is removed, trace is not blanked out but sweep runs in AUTO (FREE RUN) mode, thereby providing a convenient state for confirming existence/absence of input signal and checking of zero level. This mode is applicable to observation of repetitive signals of 50 Hz or over.</p> <p>TV ②① : TV sync separator circuit is connected to the trigger circuit. Being linked to TIME/DIV switch ①③, trigger circuit is automatically switched to TV-V or TV-H sync. signal. When no trigger signal is applied, sweep runs in AUTO (FREE RUN) mode.</p>
②④	CAL 1 Vp-p	<p>Output terminal which provides a calibration voltage used for oscilloscope sensitivity adjustment and probe calibration. The calibration voltage is 1 Vp-p ($\pm 3\%$), positive-going square wave of about 1 kHz.</p>

772117

3.2 Explanation of Rear Panel (See Fig. 2)

No.	Panel mark	Description
②5		AC power cord of the oscilloscope
②6		Studs for using the oscilloscope in a vertical attitude. Also used as AC power cord take-up posts.
②8	Z-AXIS INPUT	Input terminal (binding post) for external intensity modulation signal. Used when intensity is controlled with an external signal or intensity markers are displayed. When not in use, this terminal must be connected to the GND terminal ②9 with the shorting bar.
②9		GND terminal (binding post). Spacing with respect to Z-AXIS INPUT terminal ②8 is 19 mm (0.75 in.).
③0	(FUZE)	Fuse holder. Fuse rating is 0.5 A for 100 V system AC line or 0.3 A for 200 V system AC line.
③1		Instrument serial number plate.

7721184
179.8.28

3.3 Explanation of Bottom Panel (See Fig. 3)

No.	Panel mark	Description
③②	ASTIG	Semi-fixed resistor for astigmatism control. So adjust this control in conjunction with the FOCUS control that the trace is made sharpest.
③③		Studs which are used also for fixing the stand.
③④		Stand for setting the oscilloscope in a slanted attitude for ease of observation. Do not use this stand when oscilloscope camera and adaptor are used.

79.8.28
772119A

772120

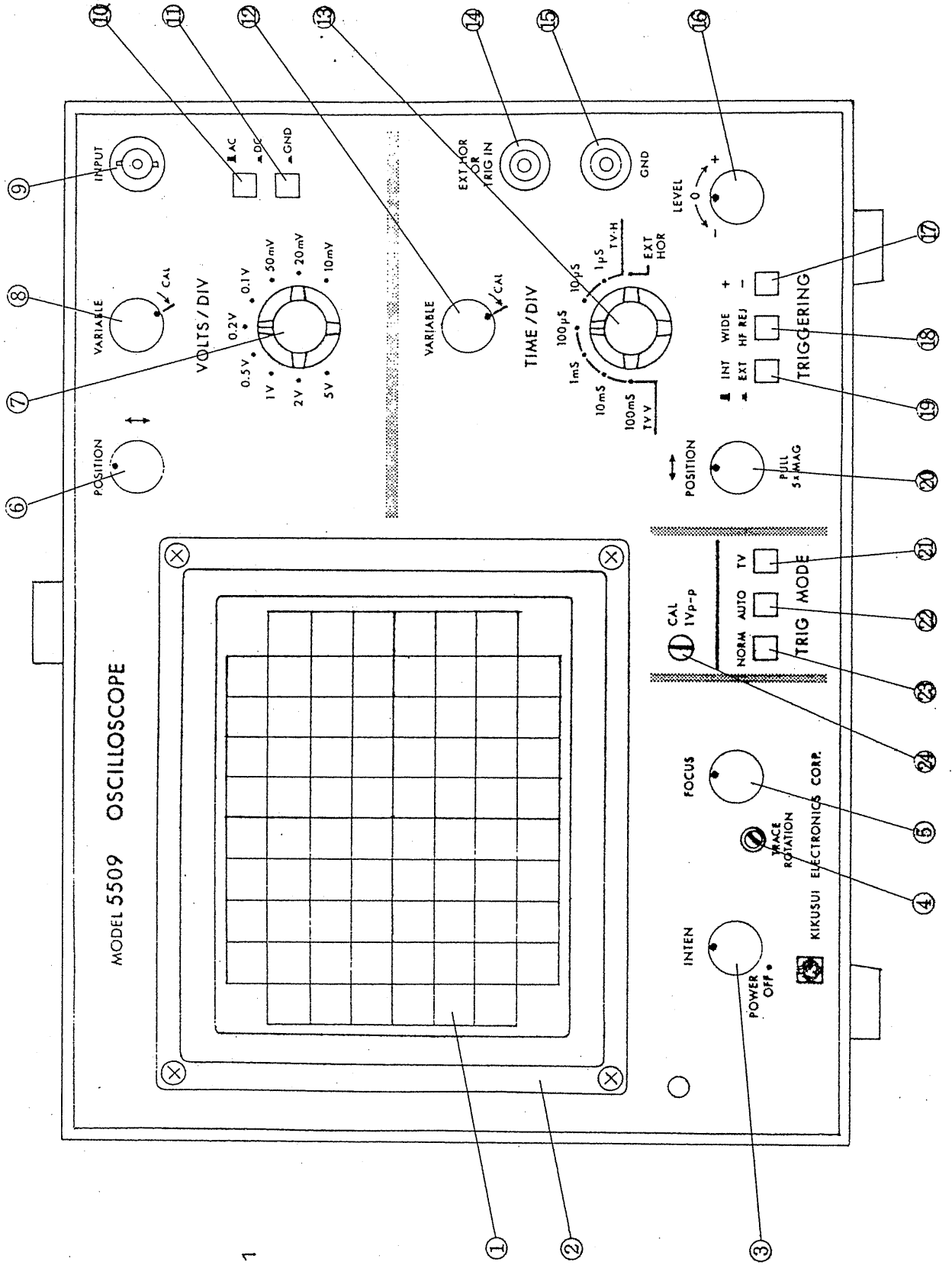

Fig. 1

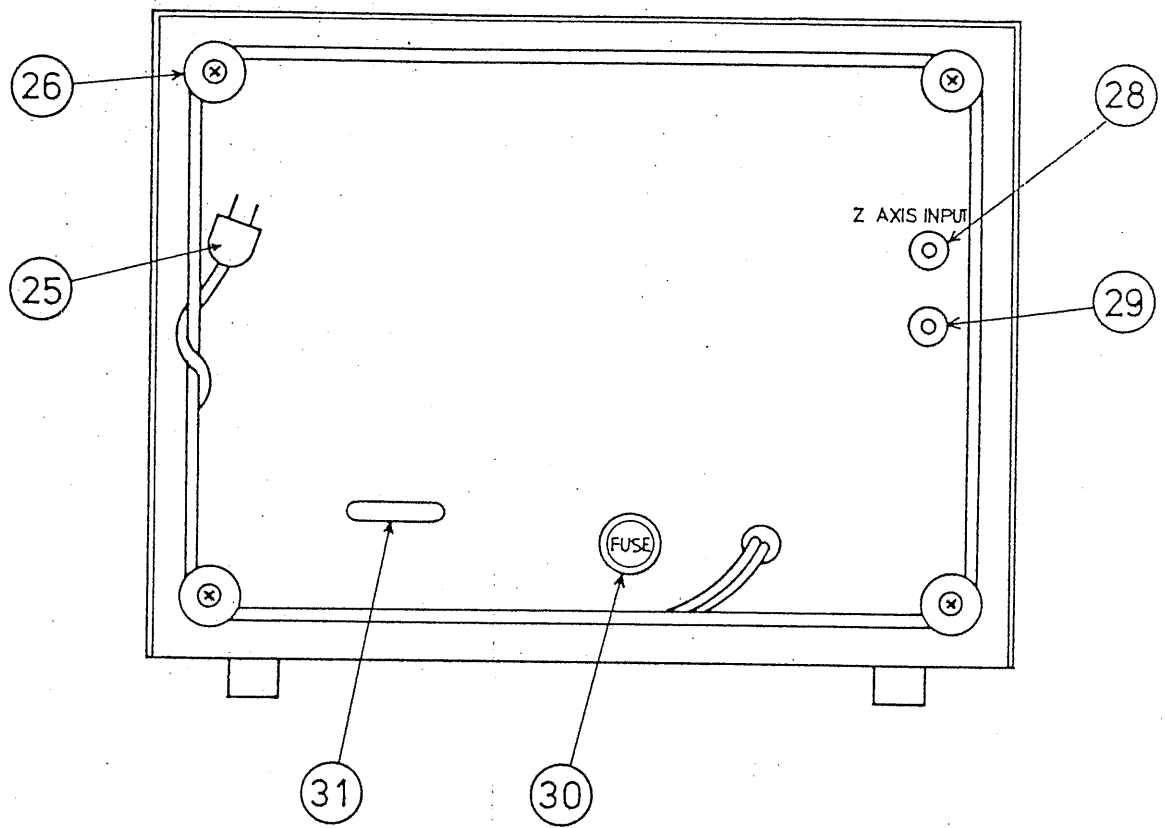

Fig. 2

79.1.22
77212-1

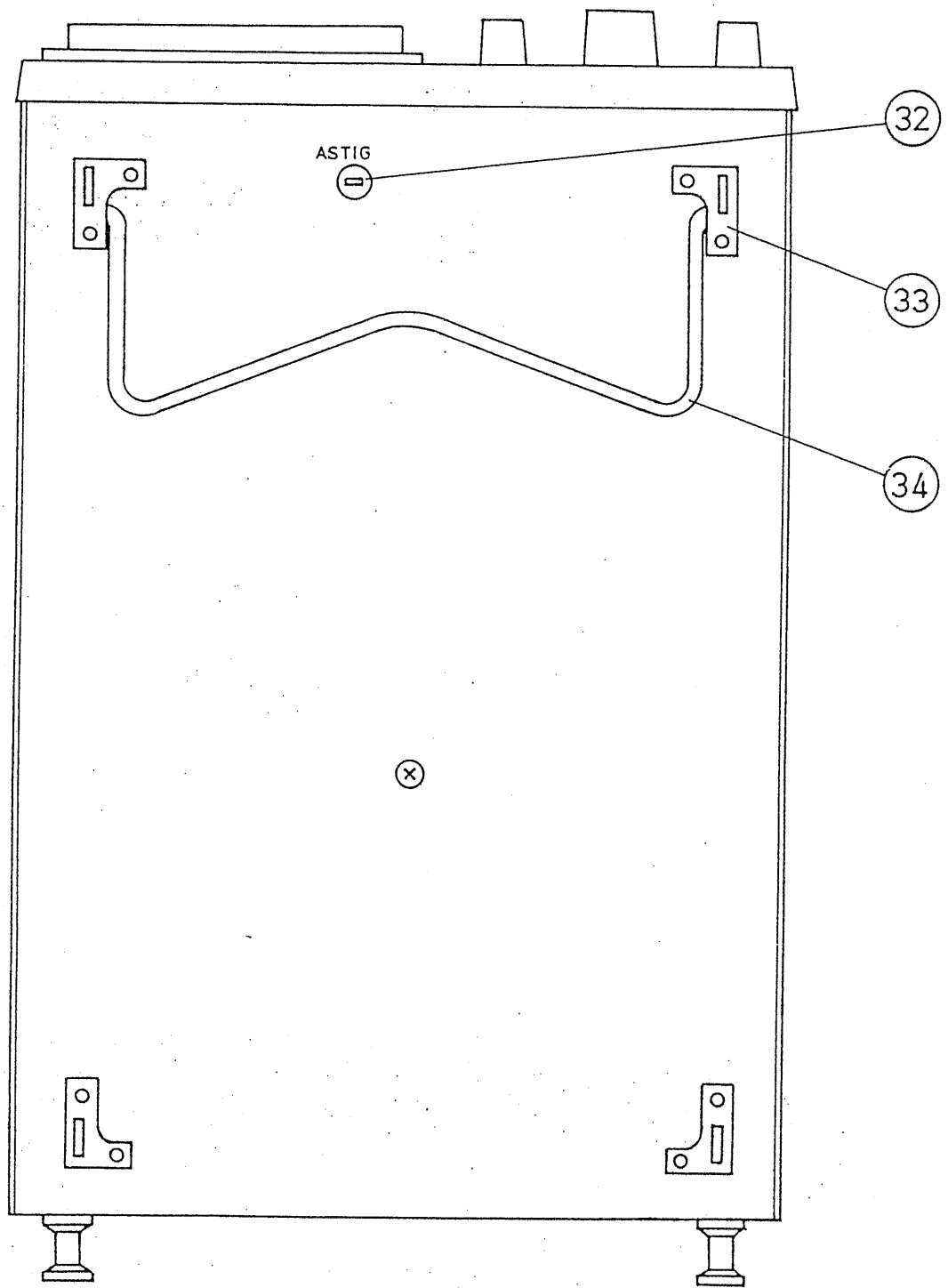

Fig. 3

3.4 Precautions in Operation

- o Line voltage:

The oscilloscope is set for operation on a 100 V $\pm 10\%$ AC line power. To operate the oscilloscope on other AC line voltage, it must be modified as explained in Para. 3.5 "AC Line Voltage Conversion." Note that the oscilloscope will not operate properly or may be damaged if it is operated on a wrong AC line voltage.

- o Ambient temperature:

The ambient temperature range for normal operation of the oscilloscope is $0^{\circ}\text{C} \sim 40^{\circ}\text{C}$ ($32^{\circ}\text{F} \sim 104^{\circ}\text{F}$).

- o Environments:

The oscilloscope must not be operated or stored in high temperature, high humidity atmosphere for a long period since such will cause troubles or shorten the life.

If the oscilloscope is operated in a strong electric or magnetic field, the displayed waveform may be distorted.

- o Intensity of CRT beam:

Do not make the CRT image excessively bright and do not leave the spot stationary for a long period, lest the CRT screen should be "burnt" shortening its life.

- o Allowable voltages of input terminals:

The maximum allowable voltages of input terminals and probe PO60-S are as shown in the below table. Note that the circuit may be damaged if a voltage larger than the allowable maximum is applied.

85.1.29

17721237

Terminal	Allowable maximum input voltage
Vertical input terminal 10 mV, 20 mV, 50 mV/DIV ranges Other ranges	400 V _{p-p} (DC + AC _p , within 1 minute) 600 V _{p-p} (DC + AC _p , within 1 minute)
Probe (P060-S) EXT HOR OR TRIG IN terminal Z AXIS INPUT terminal	600 V _{p-p} (DC + AC _p , within 1 minute) 100 V _{p-p} (DC + AC _p) 50 V _{p-p} (DC + AC _p)
Repetition frequency of AC: Not higher than 1 kHz	

3.5 Line Voltage Conversion

As a general rule the 5509 Oscilloscope is shipped being set for use on a 100 V AC line power. To operate the instrument on other AC line voltage, its AC power input circuit (power connector B, tap, and fuse) must be converted referring to the following table.

Nominal tap voltage	Applicable voltage range	Fuse	Connector
100 V 110 V 120 V	90 ~ 110 V 99 ~ 121 V 108 ~ 132 V	0.5 A	Connect the power connector B to the "100 V SYSTEM" pins.
220 V 230 V 240 V	198 ~ 242 V 207 ~ 253 V 216 ~ 264 V	0.3 A	Connect the power connector B to the "200 V SYSTEM" pins.

85.1.29
772124B

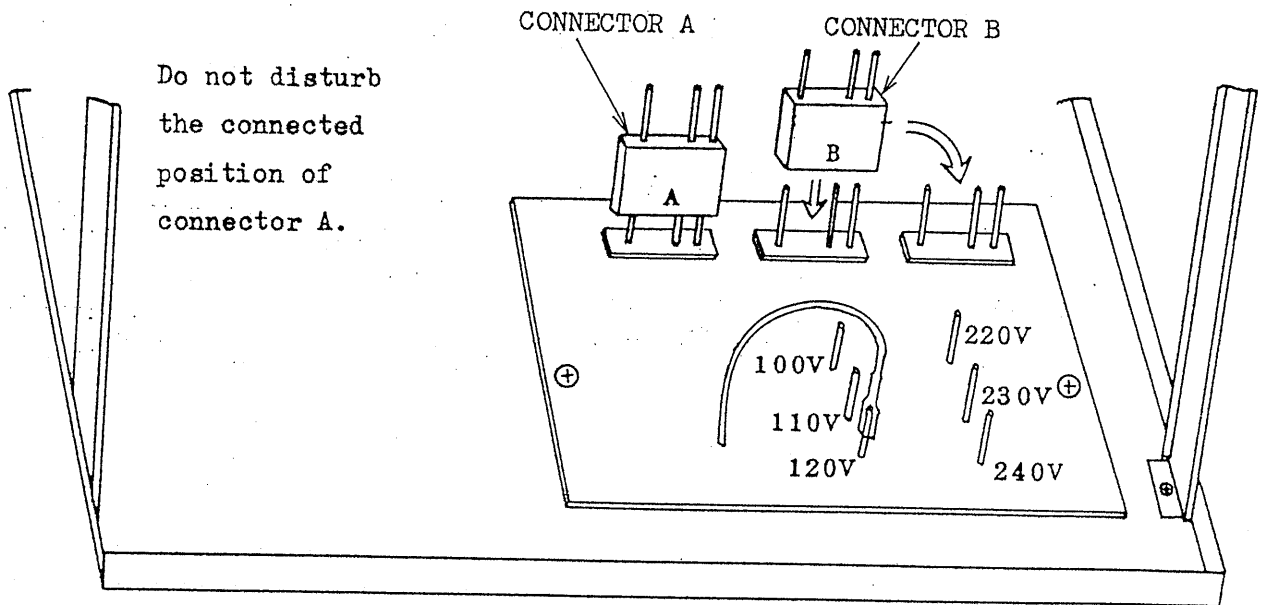

Do not disturb
the connected
position of
connector A.

Connect the selector cord to
the corresponding pin.

Fig. 4

Notes:

- o Before performing AC line conversion, ensure that the AC power cord is disconnected from the AC power line outlet.
- o Use a cord and a plug which meet the requirements of the line power to be used.
- o The line filter capacitor is not required to be replaced.

772125

4. OPERATING PROCEDURE

4.1 Preliminary Procedure (See Fig. 1)

Before turning-on the oscilloscope power, set the knobs on the front panel as shown in the following table:

Item	No.	Setting
INTEN (POWER OFF)	③	Extremely counterclockwise position (OFF position)
FOCUS	⑤	Mid-position
↕ POSITION	⑥	Mid-position
VOLTS/DIV	⑦	0.5V range
VARIABLE	⑧	↙ CAL position
<input checked="" type="checkbox"/> AC <input type="checkbox"/> DC	⑩	<input checked="" type="checkbox"/> AC position
GND	⑪	<input type="checkbox"/> GND position
VARIABLE	⑫	↙ CAL position
TIME/DIV	⑬	1mS range
TRIGGERING	⑰	<input checked="" type="checkbox"/> "+" position
	⑱	<input checked="" type="checkbox"/> WIDE position
	⑲	<input checked="" type="checkbox"/> INT position
↔ POSITION	⑳	Mid-position, depressed state
TRIG MODE	㉑	<input type="checkbox"/> AUTO position
	㉒	
	㉓	

79.1.22

772/26

Connect the power cord to an AC line outlet of the correct voltage and, then, proceed as follows:

- 1) Turn the INTEN knob (3) from the POWER OFF position to the extremely clockwise position. A click sound (power-on sound) is generated and the LED light at an upper left of the knob.
- 2) In about 10 seconds after the above, a bold horizontal trace line will be displayed on the CRT screen. Adjust the trace to an appropriate brightness with the INTEN knob (3).

If no trace is displayed within about 20 seconds, repeat setting of each knob as indicated in the above table.

- 3) Connect the signal of the CAL (1 Vp-p) terminal to the vertical INPUT terminal (9) using the lead with BNC connector or other appropriate cord.
- 4) Set the GND (11) switch in the popped up state () , and so adjust the LEVEL knob (16) that the displayed waveform becomes stationary. A waveform as shown in Fig. 5 should be displayed on the CRT screen.

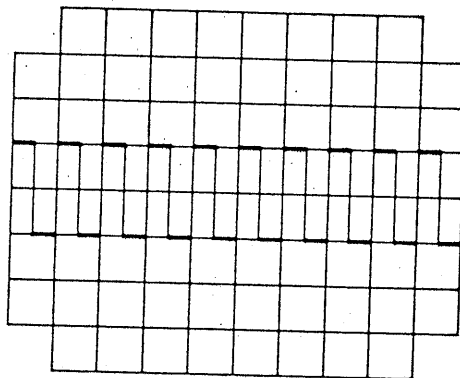

Fig. 5

79.1.22
772121

- 5) So adjust the FOCUS knob (5) that the displayed waveform becomes sharpest.
- 6) So adjust the TIME/DIV switch (13) and VOLTS/DIV switch (7) that an appropriate number of peaks are displayed with an appropriate amplitude.
- 7) Align the displayed waveform with the graticule by adjusting the vertical POSITION knob (6) and horizontal POSITION knob (20), and determine the voltage (V) and period (T).

The above explanation is for the basic operating procedure of the oscilloscope. For measurement of a signal, refer to Section "Measuring Procedure." General operation methods of the oscilloscope are explained in the following sub-sections.

4.2 Selection of TRIG MODE

An appropriate trigger mode should be selected taking into consideration the waveform of the measured signal and the functions of the trigger modes which are explained in the following.

1) NORM mode:

When the trigger level is within the trigger input signal amplitude, a trigger pulse signal is produced and this signal drives the sweep circuit so that a stationary waveform is displayed on the CRT screen. This state is called "trigger is triggered" or "triggering is effected."

When no trigger input signal is applied or the trigger level is not within the trigger input signal amplitude, the sweep circuit is in the standby state and no trace is displayed on the CRT screen. This state is called "trigger is not triggered" or "no triggering is effected."

772128

When trigger is not triggered, the fact may be mistaken for an incorrect setting (for example, mistaken for incorrect setting of the INTEN knob (3) or vertical POSITION knob (6). Therefore, the AUTO mode should be used excluding the following cases:

- (i) The repetition frequency of the trigger input signal is lower than 50 Hz.
- (ii) The waveform is required to be displayed on the screen only when the input signal (trigger signal) is applied.

2) AUTO mode:

A stable sweep operation can be obtained when the trigger input signal is higher than 50 Hz. When triggering is OFF, the sweep runs in the AUTO (FREE RUN) mode. Even at a fast sweep speed, a bright trace is displayed and the ZERO level can be easily checked. Thus, the AUTO mode is most convenient for general waveform display.

3) TV mode:

This triggering mode is used for observation of TV video signals. The TV video signal applied to the trigger input circuit is fed to a sync. separation circuit of picking off the synchronization signal and this signal is used as the triggering source signal. Thus, the TV video signal is displayed very stably.

Also, being linked to the TIME/DIV knob, triggering is triggered to the vertical sync. signal (TV·V) for the ranges of 100 msec/DIV ~ 100 μ sec/DIV and to the horizontal sync. signal (TV·H) for the ranges of 10 μ sec/DIV ~ 1 μ sec/DIV.

772129

Set the SLOPE in conformity with the polarity of the sync. pulses of the video signal as shown in Fig. 6.

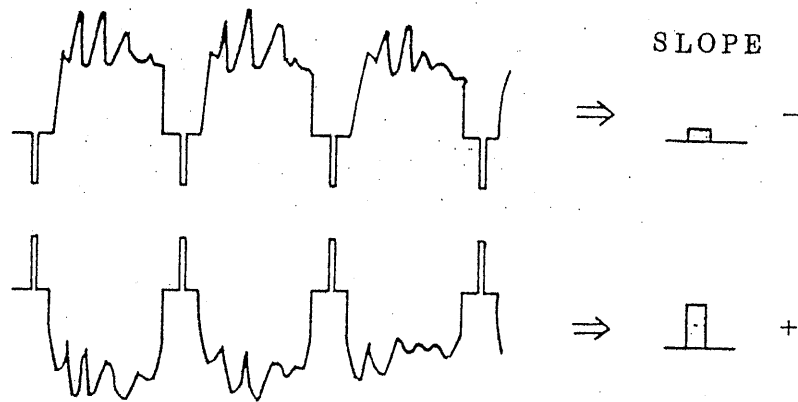

Fig. 6

4.3 Selection of TRIGGERING Switches

1) Functions of INT () / EXT () selector switch (19)

This switch selects the signal source (trigger signal or trigger source) of the trigger circuit.

o INT position

The signal applied to the vertical input terminal is picked off at a certain point of the vertical amplifier and applied to the trigger circuit. Since the trigger signal is always proportional to the amplitude on the screen, a stable waveform can be displayed on the CRT screen.

772130

o EXT position:

An external signal applied to the EXT HOR OR TRIG IN terminal 14 is fed to the trigger circuit. If the external signal has a certain synchronous relationship with the measured signal, a stable waveform is displayed on the screen. This function may be used in the reverse manner, that is, to check whether there is any synchronous relationship between two signals or not.

2) Functions of WIDE () / HF REJ () selector switch (18)

This switch selects the mode of coupling between trigger source and trigger circuit.

o WIDE position:

The trigger signal is fed to the trigger circuit through an AC-coupling circuit with a low range cut-off frequency of 3 Hz (-3 dB). This coupling mode is used in general.

o HF REJ position:

The trigger signal is fed to the trigger circuit through an AC-coupling circuit which has a low pass filter (3 Hz - 50 kHz, -3 dB) which eliminates the HF and noise components superimposed on the trigger signal. This coupling mode is used when triggering is to be effected with the low frequency components alone.

3) Functions of "+" () / "-" () selector switch (17)

o "+" position:

The sweep is triggered when the trigger signal crosses the trigger level from the negative side to the positive side (positive slope triggering).

772131

o - "-" position:

The sweep is triggered when the trigger signal crosses the trigger level from the positive side to the negative side (negative slope triggering).

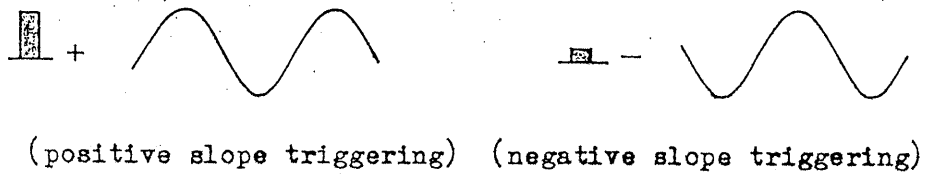
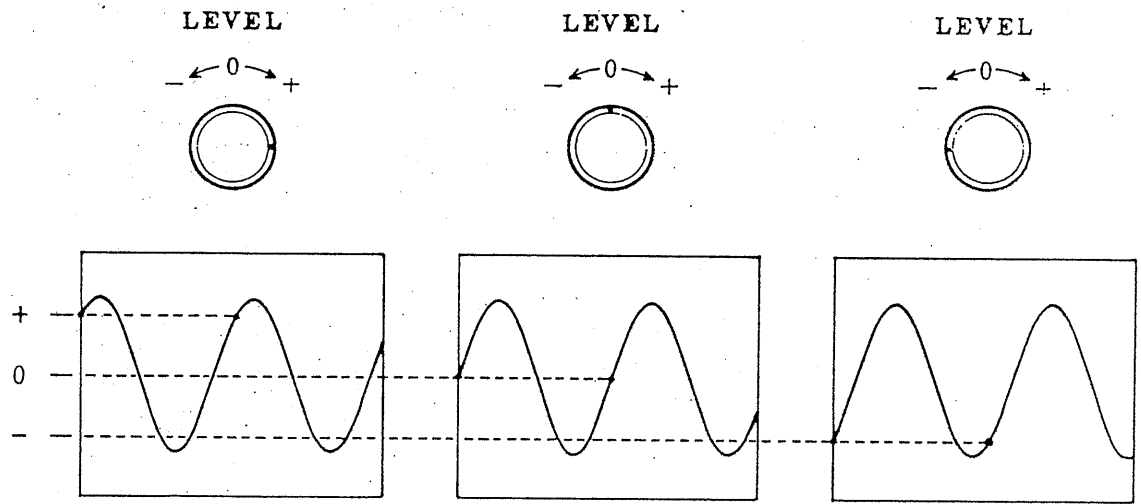

Fig. 7

4.4 Adjustment of LEVEL Knob

This knob is used to adjust the triggering level so that a stable waveform is displayed on the CRT screen. The sweep is triggered when the trigger signal crosses the trigger level increases in the positive direction when the knob is turned in the " $\rightarrow +$ " direction and it decreases when the knob is turned in the " $\leftarrow -$ " direction. The trigger level adjustment range with the LEVEL knob is as shown in Fig. 9.



(1 kHz sine wave, "+" slope)

Fig. 8

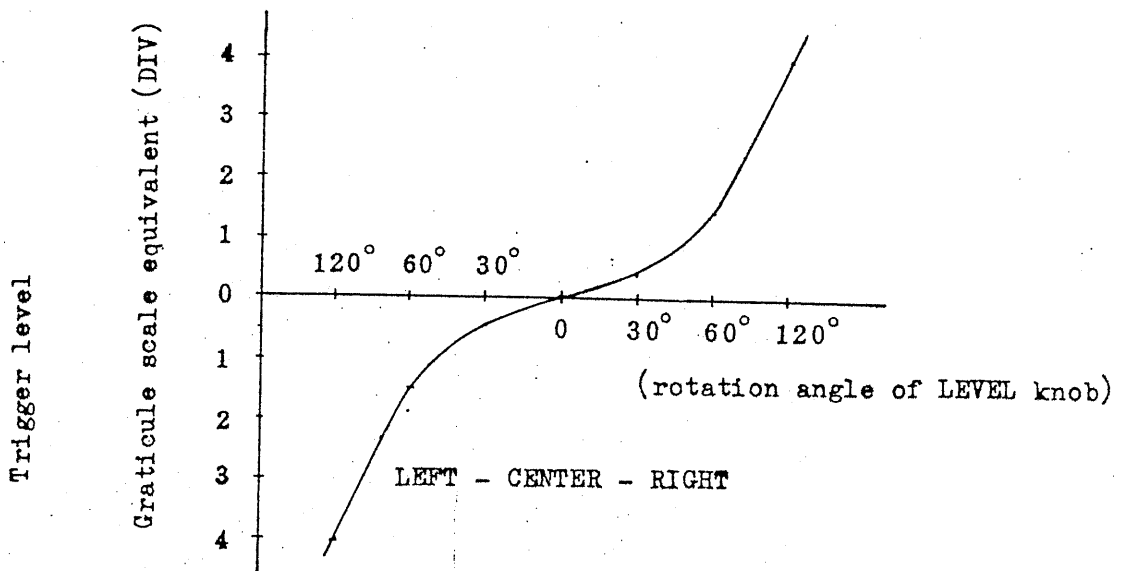

Fig. 9

79.1.22
772137

4.5 Sweep Magnification (PULL 5 × MAG)

When a part of the input signal waveform is required to be enlarged for observation of details, a faster sweep speed may be used. However, if the part to be enlarged is apart from the start of the sweep, the part may run out of the screen. In such a case, by pulling out the HORIZONTAL POSITION knob (20), the displayed waveform can be magnified by 5 times to right and left from the center of the screen as shown in Fig. 10.

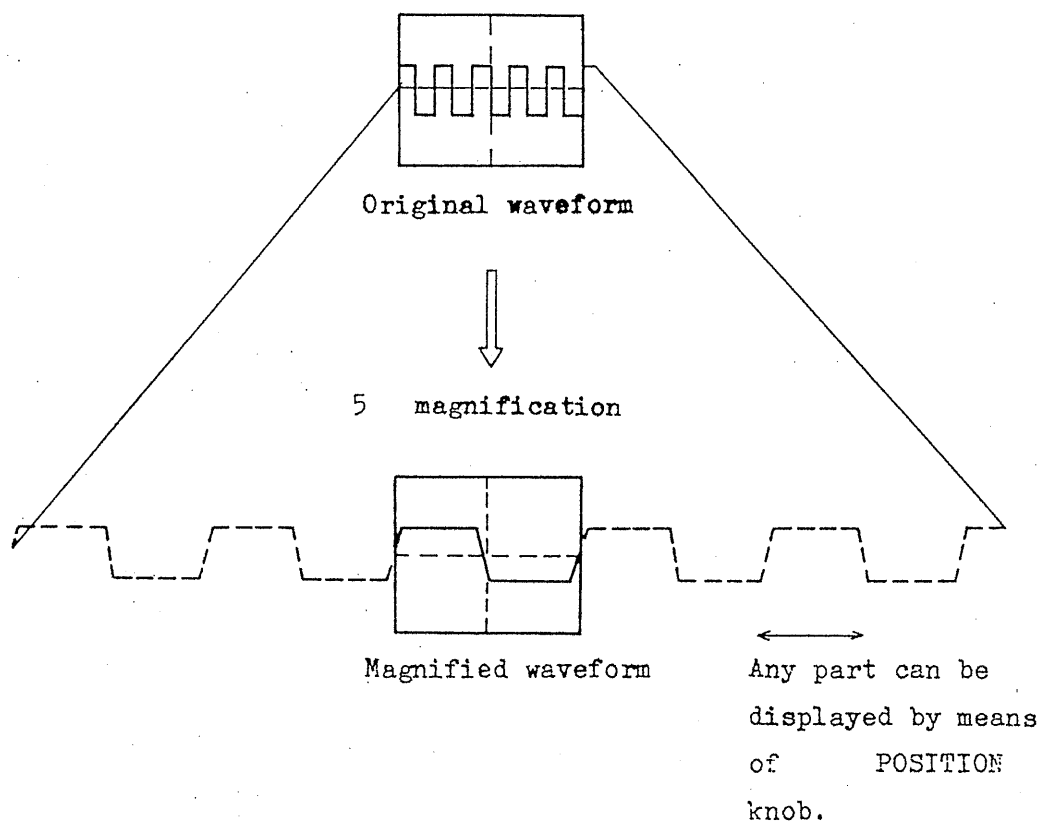

Fig. 10

When magnified, the sweep speed is as follows:

Indication of TIME/DIV switch $\times 1/5$

The maximum sweep speed of the oscilloscope when this magnification function is effected becomes as follows:

$$1 \mu\text{sec}/\text{DIV} \times 1/5 = 0.2 \mu\text{sec}/\text{DIV}$$

When the trace is magnified, its intensity becomes lower. Therefore, the use of the magnification feature should be limited to the following cases:

- (1) When a part apart from the start of the sweep is required to be enlarged.
- (2) When a sweep speed faster than 1 $\mu\text{sec}/\text{DIV}$ is required.

4.6 EXT HOR (External Horizontal) Operation

When the TIME/DIV switch is set in the EXT HOR position, the instrument can be used as an alignment scope or an X-Y scope with the EXT HOR OR TRIG IN terminal (14) as X axis and the vertical INPUT terminal (9) as Y axis. The operation of the Y axis remains the same with that in regular operation.. The X axis operates with a frequency range of DC ~ 500 kHz (-3 dB) and a sensitivity of 200 mV/DIV or over which is continuously variable (attenuatable) with the VARIABLE knob. When the calibration voltage is applied to both X and Y axes and their sensitivities are appropriately adjusted, for example, a Lissajous figure for square waves can be displayed as shown in Fig. 11.

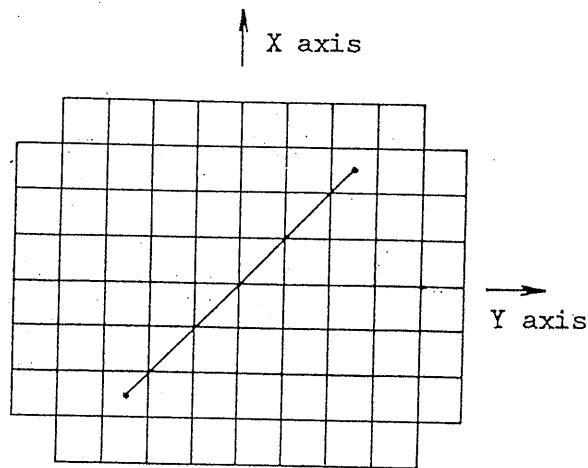

X axis: VARIABLE knob (12) set in CAL position

Y axis: 0.2 V/DIV

Fig. 11

Note: When a high frequency signal is measured in the EXT HOR mode, may attention to frequency response difference and phase difference between X and Y axes.

4.7 Z-AXIS INPUT (External Intensity Modulation) Operation

The Z-AXIS INPUT terminal is used to control or modulate the trace intensity with an external signal. Disconnect the shorting bar of the Z-AXIS INPUT terminal (28) at the oscilloscope rear (See Fig. 2) and apply the external signal between this signal and the terminal. When this terminal is not used, connect the GND shorting bar.

112136

The sensitivity of this level is sufficiently high for controlling with a TTL level signal. For the maximum allowable input voltage, refer to Sub-section 3.4 "Precautions in Operation." Since coupling is direct and DC-wise, remote control of trace intensity with an external signal also is possible.

5. METHODS OF MEASUREMENTS

5.1 Connection Method of Input Signal

The input impedance of the oscilloscope as viewed from the vertical input terminal is 1 MΩ with capacitance approximately 25 pF in parallel. When the probe P060-S is used, the impedance increases to resistance 10 MΩ with capacitance approximately 20 pF in parallel.

There are various methods of connection between measured signal source and oscilloscope. The most popular methods are with general wires, with shielded wires, with a probe, or with a coaxial cable. Suitable ones are used taking the following factors into consideration.

Output impedance of input signal source

Level and frequency of input signal

External induction

Distance between input signal source and oscilloscope

Types of input signals and connection methods are tabulated in the following:

85. 1. 29

972/388

Type of input signal		Connection method		General wire	Shielded wire	Probe	Coaxial cable	Others
		Near	Far					
Low frequency	Low impedance	Near		○	○	○	○	
		Far			○		○	
	High impedance	Near			⊗	○	⊗	
		Far			⊗		⊗	
High frequency	Low impedance	Near				○	○	
		Far					○	
	High impedance	Near				○	⊗	
		Far						

(○: Good, ⊗: Fair)

o Connection with general wires:

Set a BNC Type Adaptor (Type 942A, accessory) to the vertical input terminal and connect general wires to the adaptor. This method is simple and the input signal is not attenuated but is susceptible to induction noise when long wires are used or when the signal source impedance is high. Another disadvantage is a large stray capacity with respect to the ground. As compared with the case the 10:1 probe P060-S is used, larger effects are caused by the stray capacity.

o Connection with shielded wire:

The use of a shielded wire prevents external induction noise. However, the shielded wire has as large stray capacitance as 50 pF/m ~ 100 pF/m and this method is not suitable when the signal source impedance is high or the measured signal frequency is high.

85.1.29
177 ± 139 C

o Connection with coaxial cable:

When the output impedance of the signal source is $50\ \Omega$ or $75\ \Omega$, the input signal can be fed without attenuation up to high frequencies by using a coaxial cable which enables impedance matching. For impedance matching, terminate the coaxial cable with a $50\ \Omega$ or $75\ \Omega$ pure-resistive resistor corresponding to the characteristic impedance of the coaxial cable, as shown in Fig. 12.

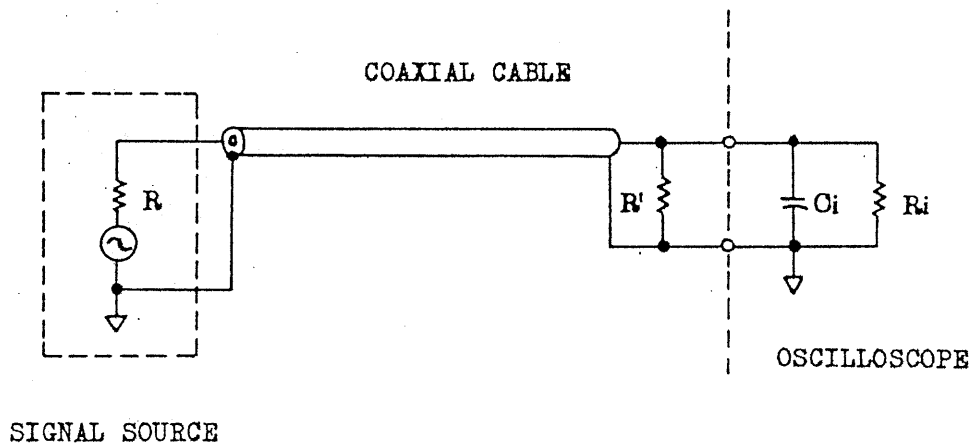

$$R = R'$$

When $R = 50\ \Omega$, use a $50\ \Omega$ coaxial cable.

When $R = 75\ \Omega$, use a $75\ \Omega$ coaxial cable.

Fig. 12

o Connection with probe:

A probe with an attenuation ratio of 10:1 is available as an accessory. The probe circuit and probe cable are shielded to prevent induction noise. The probe circuit makes up a wide-range attenuator in conjunction with the input circuit of the oscilloscope, thereby enabling a distortionless connection from DC to high frequencies. When the probe is used, although the

80.8/2
772140A

signal level is attenuated to 1/10, the input impedance becomes very high (resistance 10 MΩ, capacitance approx. 20 pF) and the loading effect on the measured signal source is greatly reduced as explained in the following.

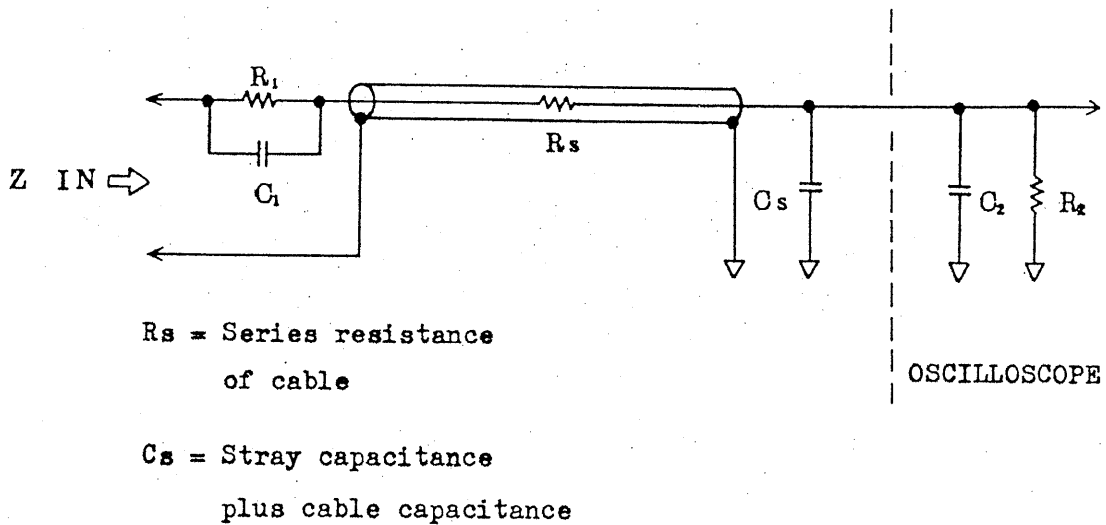

Fig. 13

The probe makes up a wide-range attenuator with its resistor R1 which make up an attenuator circuit with respect to input resistor R2 of the oscilloscope and with its capacitor C1 which compensates for input capacitor C2 of the oscilloscope and stray capacitance (Cs) of the cable. The input impedance Z_{IN} is expressed as follows:

$$Z_{IN} = \frac{R_1 + R_2}{C (R_1 + R_2) + 1}$$

$$C = \frac{C_1 \times (C_2 + C_s)}{C_1 + C_2 + C_s}$$

Attenuation factor A is expressed as follows:

$$A = \frac{R_2}{R_1 + R_2} \left(+ \frac{1M\Omega}{9M\Omega + 1M\Omega} \approx \frac{1}{10} \right)$$

The terms enclosed in the parentheses are for the factor when the probe (accessory) is used.

Precautions:

- o Observe the maximum allowable input voltages mentioned in Section 3.4.
- o Do not fail to use the ground lead supplied.
- o Before commencing measurement, accurately adjust the phase of the probe without fail.
- o Do not apply unreasonably large mechanical shocks or vibration to the probe. Do not sharply bend or strongly pull the probe cable.
- o The probe unit and tip are not highly heat resistant. Do not apply a soldering iron to a circuit close to the point where the probe is left hooked up.

5.2 Voltage Measurement

To measure an AC signal which has no DC component or to measure the AC component alone of a signal which has a DC component superimposed on the AC component, set the vertical input AC/DC selector switch (10) in the AC position. To measure a signal which has a DC component, set the switch in the DC position.

Before commencing voltage measurement, set the VARIABLE attenuator knob (8) to the CAL position and calibrate the sensitivity to the value indicated by the VOLTS/DIV selector (7).

8173
772143

Apply the signal to be measured, display the signal with an appropriate amplitude on the screen, and determine the amplitude on the graticule. (For DC voltage measurement, determine the shifted distance of the trace.) The voltage can be known as follows:

- (1) When measured signal is directly applied to input terminal:

$$\text{Voltage (V)} = \text{Deflection amplitude (DIV)} \times \text{Indication of VOLTS/DIV switch}$$

- (2) When the 10:1 probe is used:

$$\text{Voltage (V)} = \text{Deflection amplitude (DIV)} \times \text{Indication of VOLTS/DIV switch} \times 10$$

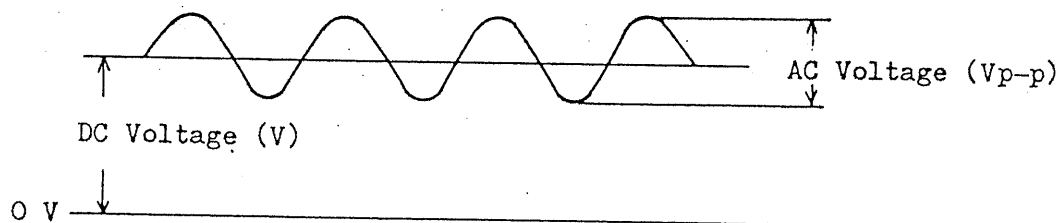

Fig. 14

5.3 Current Measurement (voltage drop method)

Connect a small-resistance resistor (R) in series in the circuit in which the current (I) to be measured flows and measure the voltage drop across the resistor with the oscilloscope. The current is known from Ohm's law as follows:

$$I = \frac{E}{R} \quad (\text{A})$$

The resistance should be as small as that it does not cause change to the measured signal source.

In the above method, currents from DC to high frequencies can be measured quite accurately. Note that the accuracy of the resistor is reflected upon the measuring accuracy.

5.4 Time Measurement

Measurement of time interval

The time interval between any two points on the displayed waveform can be measured by setting the TIME/DIV VARIABLE knob (12) in the CAL position and referring to the indication of the TIME/DIV switch (13).

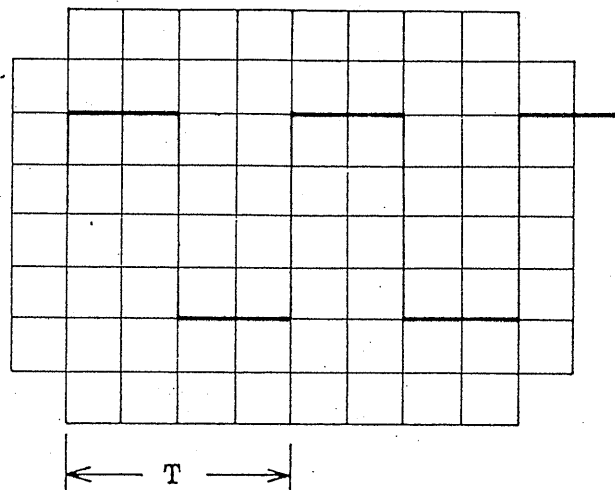

Fig. 15

$$\text{Time } T \text{ (sec)} = \text{Indication of TIME/DIV} \quad \text{Horizontal span (DIV)}$$

When the sweep is magnified ($5 \times \text{MAG}$ (20)), the time is $1/5$ of the value determined as above.

5.5 Frequency Measurement

- o Frequency measurement by determining time (T) per one cycle of the displayed waveform:

Time T (period) is measured as explained in Para. 5.4 and the frequency is known by using the following formula.

$$\text{Frequency } f \text{ (Hz)} = \frac{1}{\text{Period } T \text{ (sec)}}$$

- o Frequency measurement with Lissajous figure (See Figs. 16 and 17):

Set the TIME/DIV switch (13) in the EXT HOR position so that the oscilloscope operates in an X-Y mode. (Refer to Para. 4.6 "EXT HOR Operation.")

Apply to the X-axis a known frequency from a signal generator (SG) and to the Y-axis the frequency to be measured. So adjust the required controls that a pattern is displayed on the overall surface of the CRT screen. Then so adjust the frequency of the signal generator that the displayed pattern becomes stationary as shown in Fig. 16. From the displayed waveform, the unknown frequency can be calculated as follows:

$$\begin{array}{l} \text{Unknown} \\ \text{frequency} \\ \text{(Hz)} \end{array} = \frac{\begin{array}{l} \text{The number of crossing points} \\ \text{over horizontal scale line} \end{array}}{\begin{array}{l} \text{The number of crossing points} \\ \text{over vertical scale line} \end{array}} \times \begin{array}{l} \text{Frequency of} \\ \text{signal} \\ \text{generator (Hz)} \end{array}$$

772145

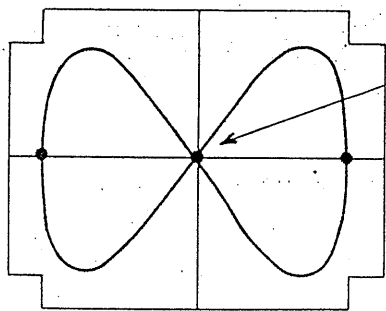

The number of crossing points is 2.

$$\frac{4}{2} = \frac{2}{1} \begin{matrix} \text{(H)} \\ \text{(V)} \end{matrix}$$

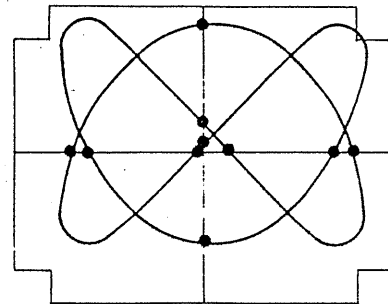

$$\frac{6}{4} = \frac{3}{2} \begin{matrix} \text{(H)} \\ \text{(V)} \end{matrix}$$

Fig. 16

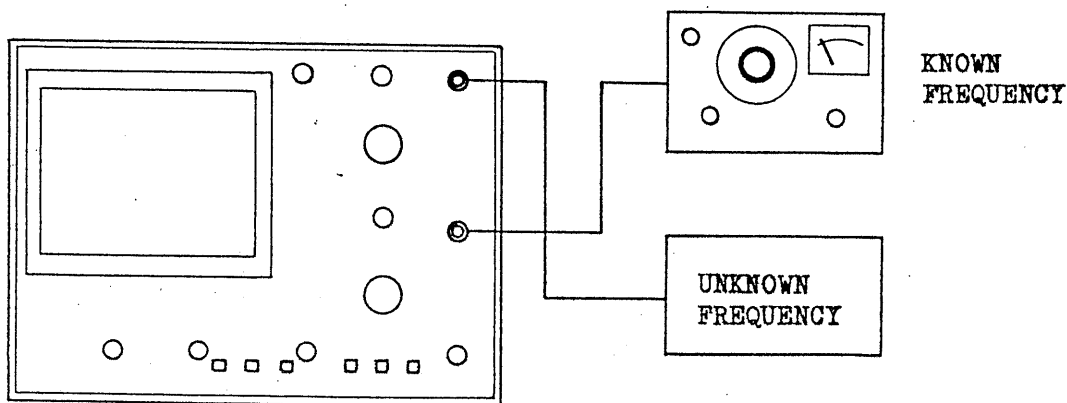

Fig. 17

5.6 Measurement of Phase Difference

- o Measurement of phase difference with Lissajous figure (See Figs. 17, 18 and 19.):

Operate the oscilloscope in the X-Y mode as explained in the paragraph for frequency measurement, and apply two signals of the same frequency (such as stereophonic signals) to the X and Y axes so that a Lissajous figure is displayed on the CRT screen. The phase difference between the two signals can be known by measuring displayed waveform and employing the following equation:

$$\text{Phase difference } \theta = \sin^{-1} \frac{B}{A}$$

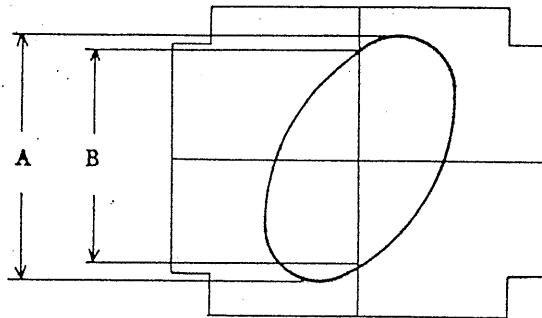

Fig. 18

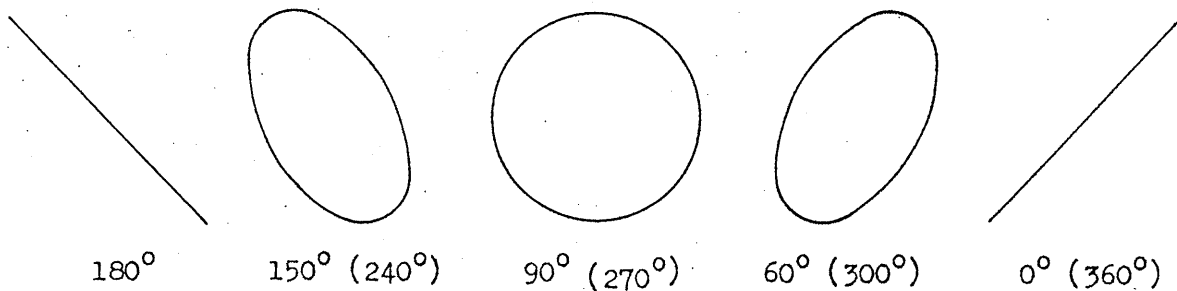

Fig. 19

772147

5.7 Characteristics of Pulse Waveform

A theoretically ideal pulse waveform is such that the signal changes instantaneously from a certain level to another level, held in this level for a certain period, and returns instantaneously to the original level. However, actual pulse waves are distorted. Nomenclature of distortions is given in Fig. 20.

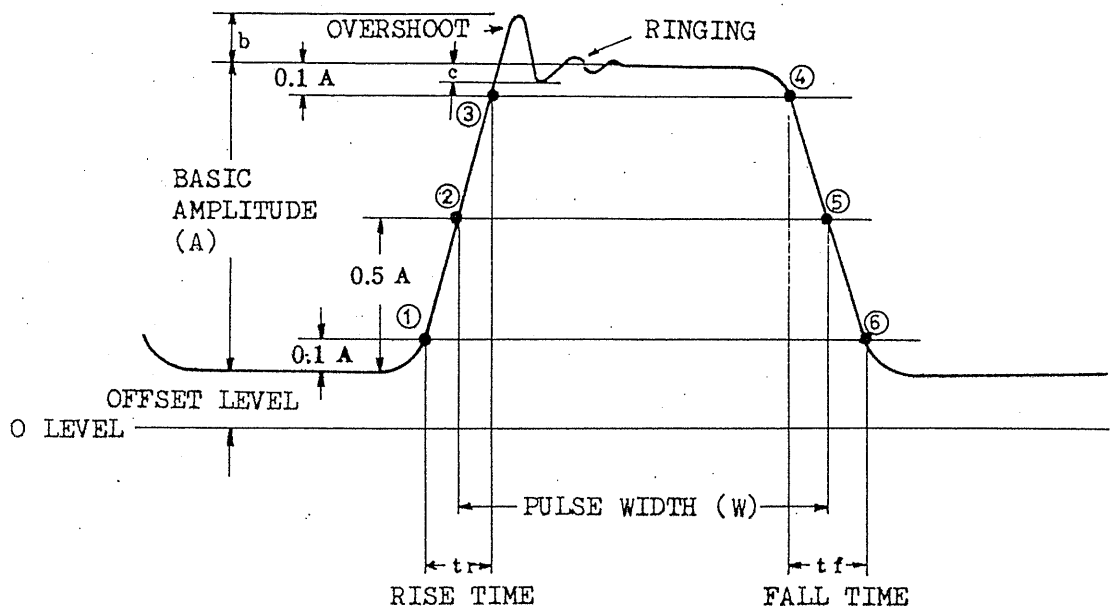

Fig. 20

Pulse amplitude: Basic amplitude (A) of pulse

Pulse width: Time between points ② and ⑤ where signal amplitude is 50% of basic amplitude

Rise time: Time between 10% basic amplitude point ① and 90% basic amplitude point ③

772148

Fall time: Time between 90% basic amplitude point ④ and 10% basic amplitude point ⑥

Overshoot: Amplitude of the first maximum excursion beyond basic amplitude. Expressed in terms of $b/A \times 100$ (%)

Ringling: Oscillation which follows the first maximum excursion. Expressed in terms of $c/A \times 100$ (%)

o Measurement of rise time:

The rise time of a pulse can be known by determining the value of t_r on the CRT screen in the method of "Time Measurement." It must be noted that t_r determined on the CRT screen includes the rise time of the oscilloscope itself. The closer the rise time of the oscilloscope (t_0) to the rise time of the measured pulse (t_n), the larger is the error introduced. To eliminate this error, calculation should be done as follows:

$$\text{True rise time } t_n = \sqrt{(t_r)^2 - (t_0)^2}$$

where, t_r : Rise time measured on CRT screen

t_0 : Rise time of oscilloscope itself
(approx. 35 nsec)

For example, when a pulse wave with rise time 100 nsec (about 3 times of that of the oscilloscope) is measured on the CRT screen, the error is approximately 6%.

772149

o Measurement of Sag

Pulse waveforms may have slanted sections as shown in Fig. 21, other than those distortions mentioned in Fig. 20. (For example, slants are caused when the signal is amplified with an amplifier which has poor low-frequency characteristics, resulting from attenuation of low frequency components.) The slanted section (d or d') is called "sag" which is calculated as follows:

$$\text{Sag} = \frac{d}{A} \text{ (or } \frac{d'}{A'} \text{)} \times 100 \text{ (\%)}$$

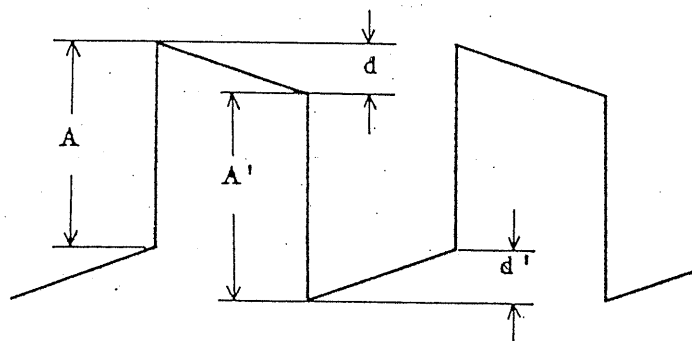

Fig. 21

Note: If the AC-coupling mode is used for measurement of a low frequency pulse, sags are caused. For measurement of low frequency pulses, use always the DC-coupling mode.

772150

6. CALIBRATION

6.1 General

The oscilloscope should be calibrated at certain time intervals. Although calibration of overall performances is most recommendable, such partial calibration may serve the purpose that the time axis alone is calibrated when the time measuring accuracy is especially important or that the vertical axis alone is calibrated when the vertical sensitivity accuracy is of prime importance. After the oscilloscope has been repaired, overall calibration is required although it depends on the type of repair. For the repair service, contact manufacturer's representative in your area.

6.2 Check and Adjustment of DC Power Supply

Before calibrating the oscilloscope, its DC supply voltages should be checked and adjusted. Check and adjust the +12V supply voltage first and the other supply voltages next. The supply voltages are shown in the following table and the check and adjustment points are indicated in Figs. 23 and 24. For removing the case, refer to Fig. 22.

Nominal voltage	Voltage range	Check and adjustment points
+5V	+4.5 V ~ +5.5 V	TP-4
+12V	+11.95V ~ +12.05V	TP-1. Adjust the "+12VADJ".
-12V	-11.80V ~ -12.20V	TP-2
+200V	+180V ~ +230V	TP-3
-1500V	-1450V ~ -1500V	TP-5

78.1.22

772151

For voltage check, measure the voltage between check point and ground using a reliable digital voltmeter. The +12V supply must be especially carefully adjusted because it provides a reference for other supplies. To measure the -1500V supply of which internal impedance is high, use a voltmeter of a high input impedance (10 M Ω or over).

Because adjustments of supply voltages largely affects vertical sensitivity and horizontal sweep time, the oscilloscope must be re-calibrated as explained in subsequent paragraphs.

* Removing the case

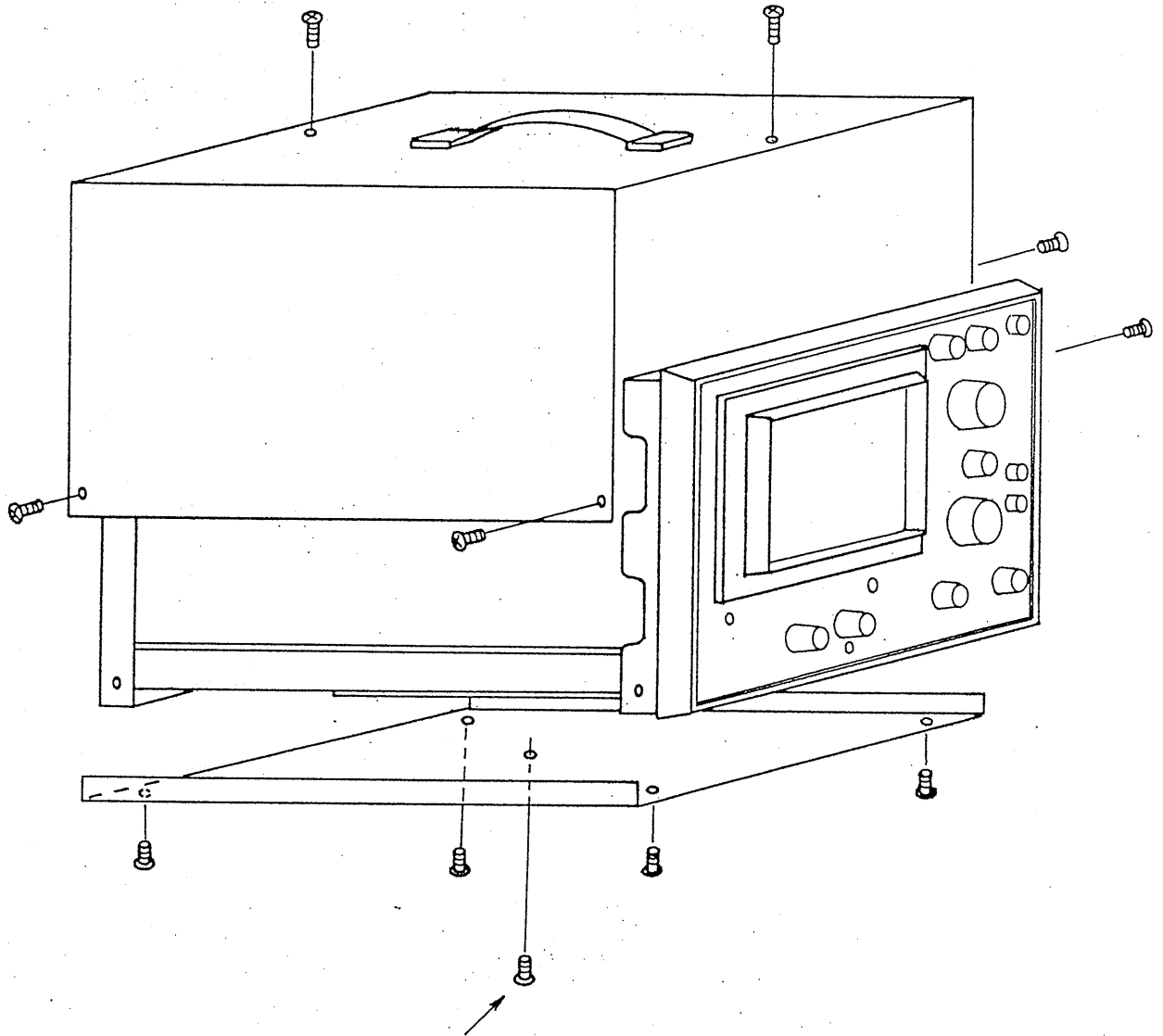

HANDLE ESPECIALLY CAREFULLY SINCE THIS
SCREW CLAMPS THE PRINTED BOARD.

Fig. 22

772153

Bottom view

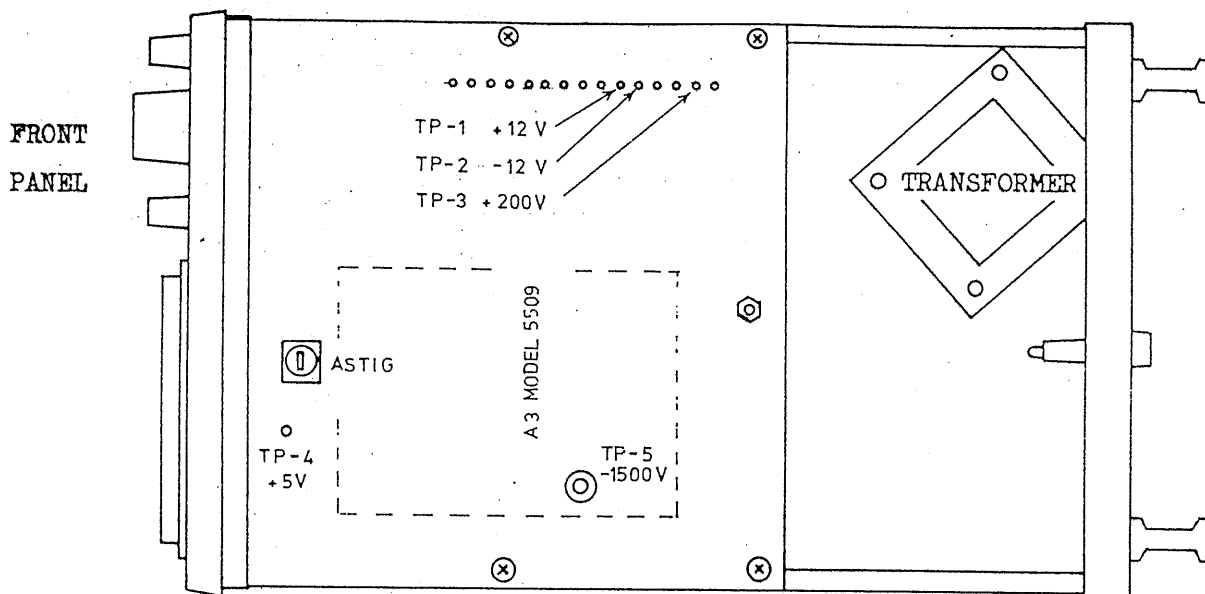

Fig. 23

Left-side view

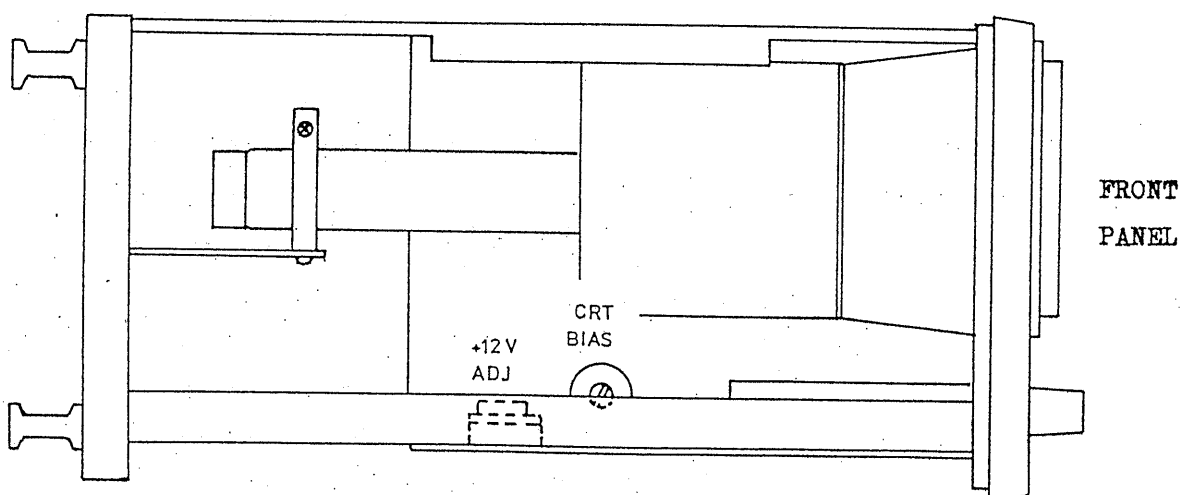

Fig. 24

6.3 Adjustment of Vertical Axis

o Adjustment of STEP BAL

This control is for minimizing the shift of the trace when the VOLTS/DIV switch (7) is turned.

- (1) Set the GND switch (11) in the GND state and display the trace on the CRT screen.
- (2) Turning the VOLTS/DIV switch between 10 mV and 50 mV positions, so adjust the STEP BAL control (see Fig. 26) that the shift of the trace becomes minimum.

o Adjustment of DC BAL

This control is for minimizing the shift of the trace when the VARIABLE KNOB (8) is turned.

- (1) Set the GND switch (11) in the GND state and display the trace on the CRT screen.
- (2) Turning the VARIABLE knob, so adjust the DC BAL control that the shift of the trace is becomes minimum.

o Calibration of sensitivity (adjustment of GAIN ADJ)

This control is for adjusting the vertical gain so that the vertical deflection amplitude conforms with the value indicated by the VOLTS/DIV switch (7). For calibration, a pulse wave generator which can provide an output signal with a voltage setting accuracy of 0.5% or better at a frequency of 1 kHz should be used.

- (1) Set the pulse wave generator output at 40 mVp-p and apply this signal to the vertical INPUT terminal (9).
- (2) Set the VARIABLE knob (8) in the CAL position and the VOLTS/DIV switch (7) in the 10 mV position, and so adjust the GAIN ADJ control (Fig. 26) that the deflection amplitude on the CRT screen is made 4 DIV.

When the above adjustment is made, other ranges also are calibrated within an accuracy of $\pm 5\%$ or better.

o Adjustment of input attenuator (phase and capacitance)

When the VOLTS/DIV switch is turned, different combinations of 1/10 input attenuator and preamplifier gain are selected. This adjustment is for phase compensation and input capacitance adjustment. Phase compensation must be made first and input capacitance adjustment next.

(1) Adjustment of phase characteristics

Using a signal which has no sag or overshoot or other distortions and which has a rise time of faster than 1 μ sec, display the signal with an amplitude of 4 DIV at each of 10 mV, 0.1 V, and 1 V ranges. So adjust the phase compensation capacitors (see the following table) that the displayed pulse signal becomes the best waveform.

(2) Adjustment of input capacitance

Connect a low-range C-meter to the input terminal of the oscilloscope and measure the input capacitance at the 10 mV range. So adjust the input capacitance compensation capacitors (see the following table) that the same capacitance as above-measured is obtained for other ranges (0.1 V and 1 V ranges) also.

Since adjustment of phase compensation capacitors and that of input capacitance compensation capacitors affect mutually, repeat these adjustments alternately for several times.

Range	Compensation capacitor	Phase compensation	Input capacitance compensation
10 mV (20, 50 mV)			(Measure the capacitance.)
0.1 V (0.2, 0.5 V)		C104	C103
1 V (2, 5 V)		C107	C106

- o Adjustment of high frequency characteristics of vertical amplifier

For this high frequency response adjustment of the amplifier, use a quality pulse wave of rise time faster than 10 nsec and repetition frequency 500 kHz.

- (1) Apply the above pulse wave signal to the input terminal, set the VOLTS/DIV switch (7) in the 10 mV position and the TIME/DIV switch (13) in the 1 μ sec position, and so adjust the signal generator output that a deflection amplitude of 6 DIV is obtained on the CRT screen.
- (2) So adjust the HF COMP trimmer capacitor (C131) of the output stage that the leading edges of the square wave become flat.
- (3) Reduce the deflection amplitude to 4 DIV, and so adjust the HF COMP trimmer capacitor (C121) of the preamplifier stage that the leading edges become flat.

79.1.22
772157

Repeat the procedures of (2) and (3) alternately for several times so that an ideal waveform is obtained.

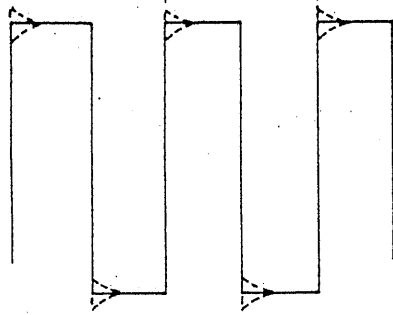

at 6 DIV

Repeat
several
times.

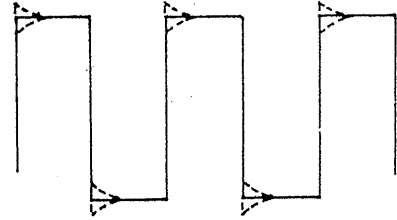

at 4 DIV

Fig. 25

772158

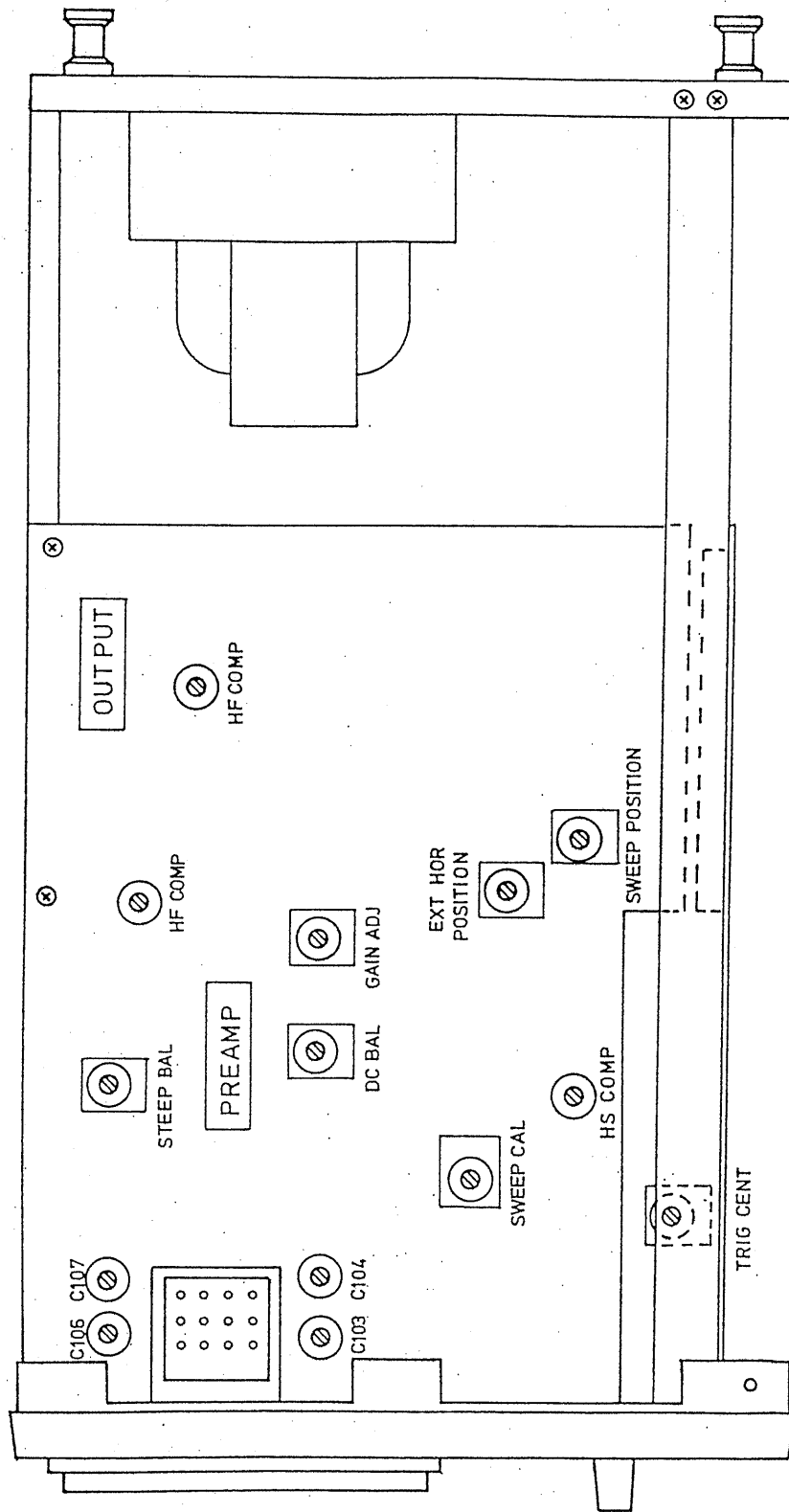

Fig. 26

6.4 Adjustment of Trigger Center (TRIG CENT)

This control is for adjusting the trigger point to the center of the deflection amplitude when the white mark of the LEVEL knob (16) is set in the upright position (noon high position).

- (1) Apply a sine wave of about 1 kHz to the vertical input and deflect the waveform fully on the CRT screen.
- (2) Select the INT trigger "+" slope and so set the LEVEL knob that its white mark is positioned in the noon high position. Under this state, so adjust the TRIG CENT control (see Fig. 26) that the trigger point is at the center of the deflection amplitude.

6.5 Adjustment of Time Axis

This adjustment is for calibrating the sweep time to the value indicated by the TIME/DIV switch. For this adjustment, use a time marker which provides accurate time intervals of 1 msec and 1 μ sec or use a signal generator which provides accurate frequencies of 1 kHz and 1 MHz.

- (1) Set the TIME/DIV switch in the 1 msec position and apply a time marker signal of 1 msec or a sine wave signal of 1 kHz to the vertical input terminal of the oscilloscope. Deflect the signal with an appropriate amplitude on the CRT screen by adjusting the generator output or oscilloscope gain.
- (2) So adjust the SWEEP CAL control (see Fig. 26) that the displayed waveform conforms with graticule divisions.
- (3) Set the TIME/DIV switch in the 1 μ sec position and apply a time marker signal of 1 μ sec or a sine wave signal of 1 MHz to the vertical input terminal of the oscilloscope.

- (4) So adjust the HS COMP control (see Fig. 26) that the waveform conforms with graticule scale divisions.

When the above calibration is complete, the sweep speeds of the remaining ranges also are calibrated with an accuracy of $\pm 3\%$. The sweep time for $5\times$ MAG operation also is calibrated.

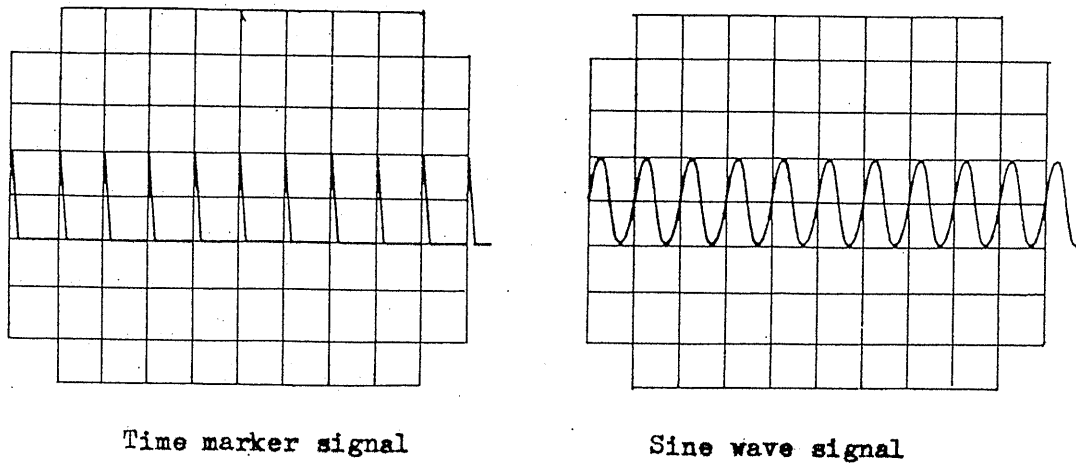

Fig. 27

6.6 Adjustment of Horizontal Axis

- o Adjustment of sweep position

So adjust the SWEEP POSITION control (see Fig. 26) that, with the white mark of the \leftrightarrow POSITION knob (20) set in the upright position (noon high position), the start position of the sweep is brought to the left-hand end of the graticule.

- o Adjustment of external sweep (EXT HOR) position

Set the TIME/DIV switch (13) in the EXT HOR position and the white mark of the \leftrightarrow POSITION knob (20) in the upright (noon high) position. So adjust the EXT HOR POSITION control (see Fig. 26) that the beam spot is displayed in the center of the CRT screen.

772161

6.7 Adjustment of CRT Circuit

o Adjustment of CRT BIAS

This control is for adjusting the operating position of the INTEN knob (3).

- (1) Set the TIME/DIV switch in the 1 msec position and display the trace on the CRT screen.
- (2) Set the white mark of the INTEN knob in the upright (noon high) position and so adjust the CRT BIAS control (see Fig. 24) that the trace is displayed on the screen with a barely discernible intensity.

6.8 Calibration of Probe

As explained previously, the probe makes up a kind of wide-range attenuator. Unless phase compensation is properly done, the displayed waveform is distorted causing measurement errors. Therefore, the probe must be properly calibrated before use. For probe calibration, use the signal of the calibration voltage output (CAL, 1 Vp-p) terminal (24) of the front panel.

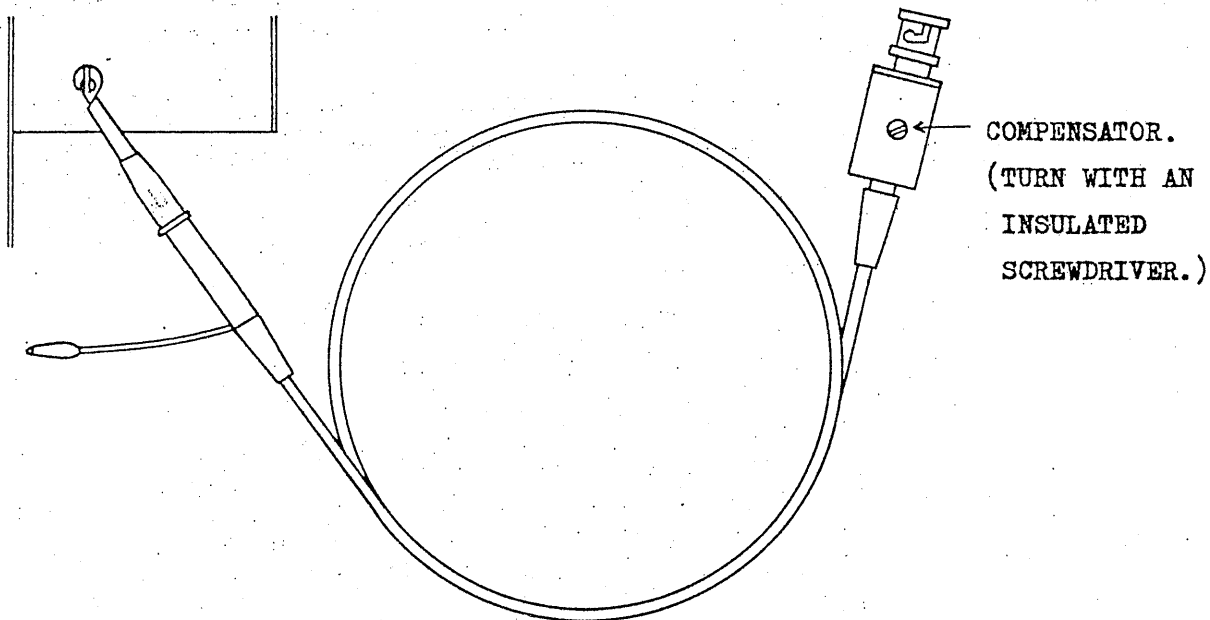

Fig. 28

Connect the probe cord to the INPUT terminal (9) and set VOLTS/DIV switch in the 20 mV position. Connect the probe tip calibration voltage output terminal and so turn the COMPENSATOR control with an insulated screwdriver that an ideal waveform as illustrated below is obtained.

Ideal

Adjustment required

Adjustment required

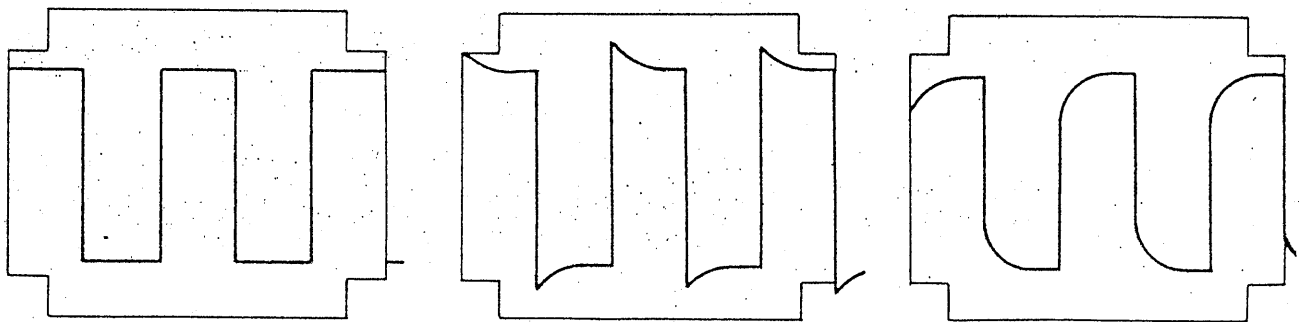
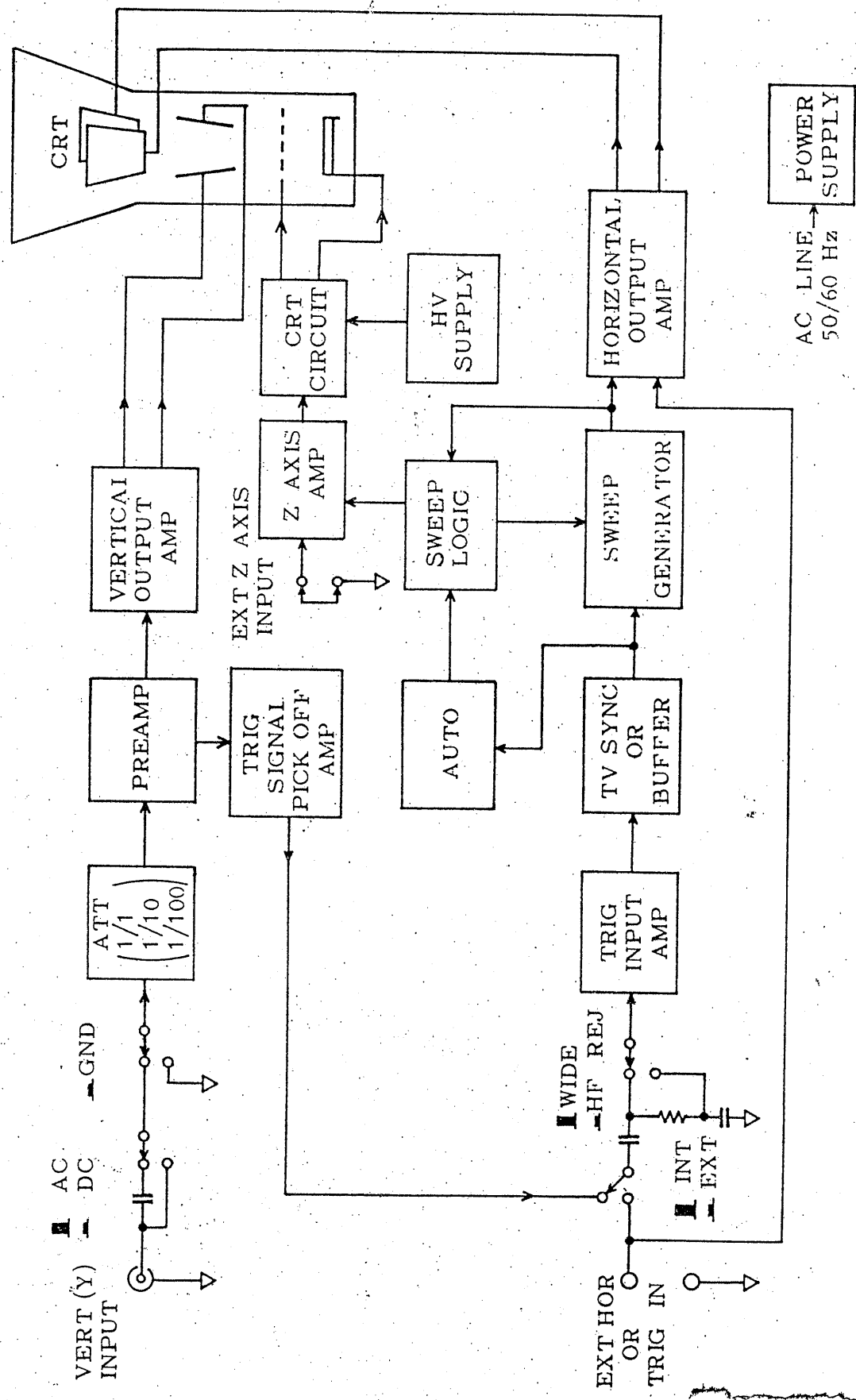

Fig. 29

772165



Block Diagram